

AX3000 Platine Terminal

Ethernet TCP/IP

Model 55E

Installation Guide

February 2002 - Ref: I55EE0210-1
Model AX3000/M55E

The reproduction of this material, in part or whole, is strictly prohibited. For additional information, please contact:

AXEL

14 Avenue du Québec
Bât. K2 EVOLIC - BP 728
91962 Courtabœuf cedex - FRANCE
Tel.: 33 1.69.28.27.27
Fax: 33 1.69.28.82.04
Email: info@axel.com

The information in this document is subject to change without notice. AXEL assumes no responsibility for any errors that may appear in this document.

All trademarks and registered trademarks are the property of their respective holders.

© - 1998-2002 - AXEL - All Rights Reserved.

1 - SAFETY NOTICES	1
2 - INSTALLATION	2
2.1 - DESCRIPTION	2
2.2 - INSTALLATION	2
2.2.1 - Monitor and keyboard	3
2.2.2 - Ethernet Connection	4
2.2.3 - Auxiliary Ports	5
2.2.4 - AC Power Connection.....	5
2.2.5 - Power On	6
3 - QUICK INSTALLATION	7
4 - CONNECTOR PIN ASSIGNMENTS.....	9
4.1 - ETHERNET PORT RJ45 (10BT).....	9
4.2 - SERIAL PORT AUX2 (RJ45).....	10
4.2.1 - RJ45-DB9 and RJ45-DB25 adaptors	11
4.2.2 - Peripheral RJ45 cables	11
4.3 - SERIAL PORT MAIN-AUX1 (25-PIN).....	12
4.4 - KEYBOARD INTERFACE	13
4.5 - VIDEO INTERFACE	14
4.6 - PARALLEL INTERFACE	15
5 - PROBLEM SOLVING	16

The AXEL AX3000 Terminal is based on a modular concept.

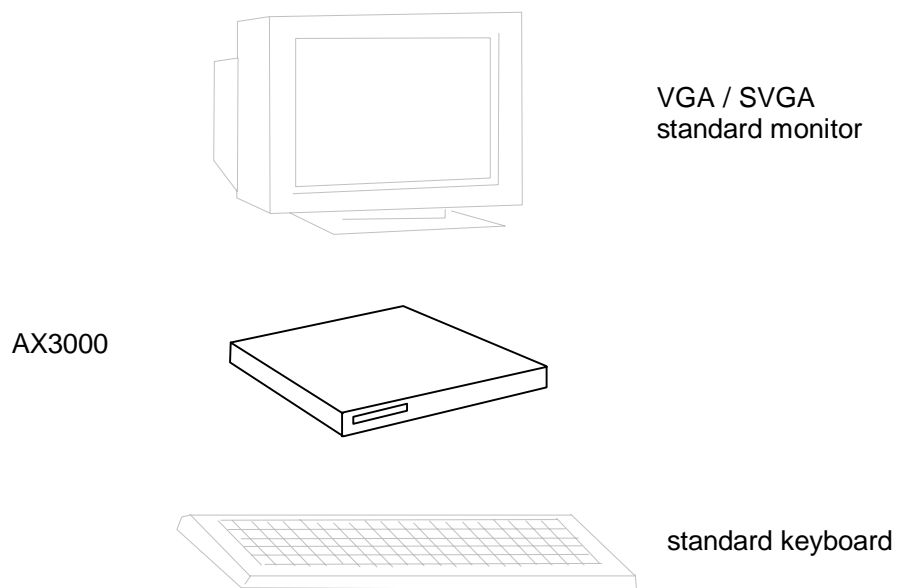

The AX3000 is totally designed and manufactured by Axel. The terminal's electronics is contained within a slim base unit which provides connections for a VGA or SVGA monitor, keyboard, system printer, serial devices and Ethernet network.

1 - SAFETY NOTICES

- Check AC voltage from the wall outlet is inside 220-240 Volts range.
- The wall outlet used must be reached easily and as nearest as possible to the AX3000 Platine Terminal to connect or disconnect the power cord.
- Make sure to power off all devices before connecting or disconnecting any one of them (monitor VGA cable, keyboard and serial or parallel cables).
- In order to ensure compliance with European EMC regulations (EN 55022), it is required that shielded cables be used when interfacing with other devices (peripherals or computers).
- To install and connect the keyboard and the monitor, refer to the respective supplier installation manuals.

2 - INSTALLATION

This chapter provides information and instructions to install the AX3000 Model 55E.

2.1 - DESCRIPTION

A green LED, located on the face plate, indicates when the AX3000 is powered on.

The AX3000 has the following connectors and switches on the rear panel:

- one power switch,
- one connector for the external power transformer cord,
- one Mini-DIN connector for an AT/PS style keyboard,
- one connector for a VGA or SVGA monitor (colour or monochrome),
- one auxiliary serial port: female 25-pin (MAIN-AUX1),
- one auxiliary serial port: RJ45 (AUX2),
- one TCP/IP port: RJ45 (10BT),
- one auxiliary parallel port: female 25-pin (PARALLEL).

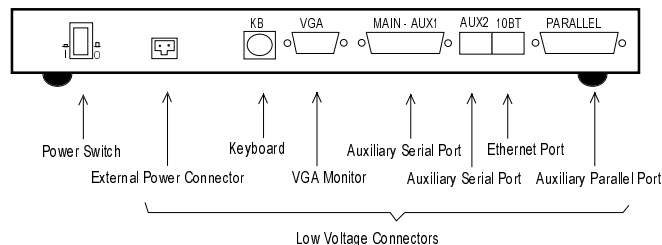

2.2 - INSTALLATION

For safety reasons and to prevent component damage, do not apply power to the AX3000 before connecting or disconnecting any cable. Do not plug in the AX3000 power cord until all other connectors have been plugged in.

Make sure the AX3000 and monitor power switches are in the OFF (0) position before connecting cables to the back panel.

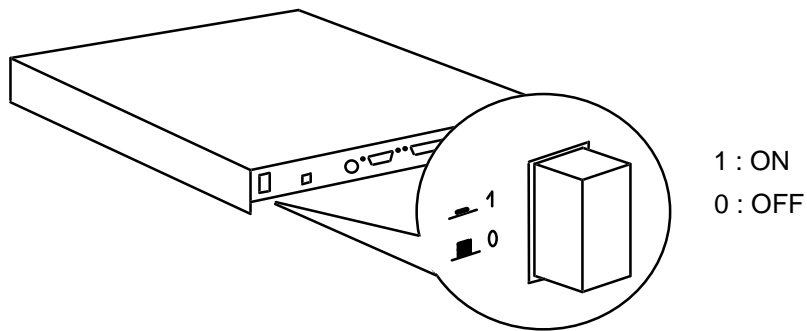

2.2.1 - Monitor and keyboard

Plug in the VGA monitor cable and the AT-compatible keyboard cable to the dedicated connectors on the terminal back panel:

- VGA Monitor (VGA): female 15-pin high density connector
- Keyboard (KB): female 6-pin Mini-DIN connector

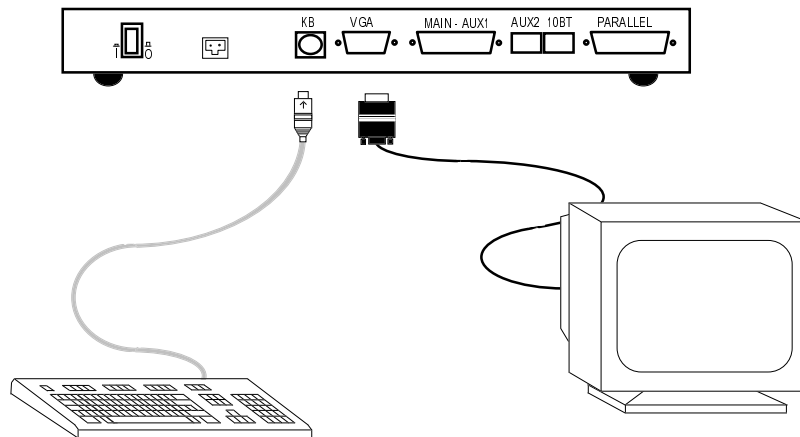

If your keyboard is fitted with a DIN connector, connect it using a DIN-to-Mini-DIN adaptor.

To comply with EMC regulations, the VGA signal cable must be shielded.

Note: when the terminal is installed in a cabinet or rack, it is essential to maintain air circulation around the VGA/SVGA monitor.

2.2.2 - Ethernet Connection

Plug the RJ45 connector on the end of the 10Base-T cable into the socket labelled 10BT on the back of the AX3000 (see chapter 4.1 for technical specifications and pin assignments).

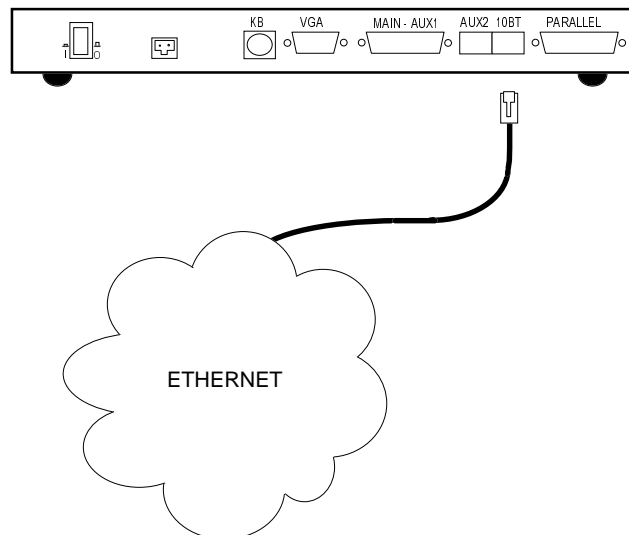

ETHERNET CONNECTION INDICATOR LIGHT: This indicator is a green LED, located next to the RJ45 connector on the rear of the terminal. It lights to indicate a satisfactory connection to the Ethernet circuit (server or hub).

Note: if the LED does not light, check that the Ethernet connector and cable both comply with the specifications listed in chapter 4.1.

2.2.3 - Auxiliary Ports

AX3000 Models 55E have three auxiliary ports as a standard feature:

- MAIN-AUX1: bi-directional serial port, female 25-pin DTE connector,
- AUX2: bi-directional serial port, RJ45 connector,
- PARALLEL: parallel port, female 25-pin connector.

Cable pin assignments are listed in chapter 4.

To comply with EMC regulations, the serial cables must be shielded.

2.2.4 - AC Power Connection

An Axel external power transformer must be used, to convert mains voltage at the wall outlet to low voltage for the AX3000 Model 35.

Before connecting, make sure the AX3000 and monitor power switches are both in the OFF (0) position.

Plug the plastic moulded cord connector of the external power transformer (ref. AXP/EC9.8) to the AX3000 power connector. Then plug the transformer into the AC wall outlet.

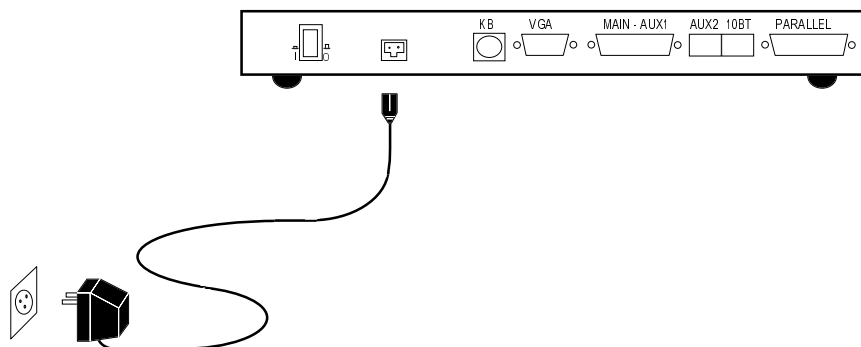

Warning: Only use the Axel external transformer supplied with your AX3000 Model 55E. Use of any other transformer may cause permanent damage to the AX3000.

Plug the monitor power cable into a grounded AC mains power socket. The monitor does **not** require low voltage power.

2.2.5 - Power On

The power switch on the rear panel controls the power supply to the AX3000.

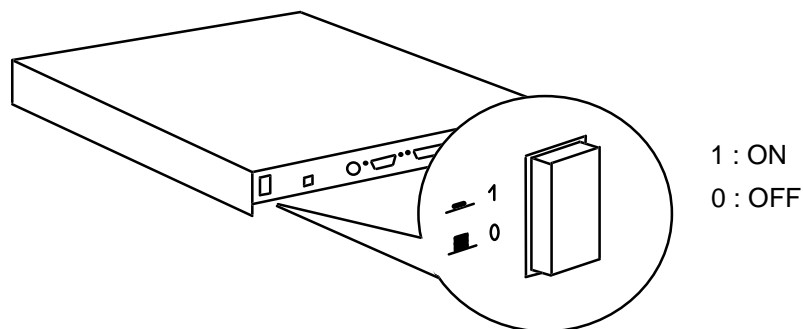

The green LED on the front of the terminal should light, and a single audible beep should be heard, to indicate that the AX3000 terminal is powered up and operating correctly.

To indicate correct keyboard initialisation after power-up, the keyboard indicator lights 'Num lock', 'Caps lock' and 'Scroll lock' should flash twice.

The green LED on the right side of the RJ45 connector on the back panel remains lit, to indicate a satisfactory Ethernet connection.

If the terminal does not function as described above (for example if it emits a continuous tone sound, or two beeps, or if an error message is displayed on the screen) refer to chapter 5. If the terminal still does not operate properly, call your service representative.

3 - QUICK INSTALLATION

This chapter describes the quick set-up procedure for the TCP/IP Platine terminal.

The following command sequence is used to enter the AX3000 Set-Up:



All the AX3000 set-up parameters (network environment, session settings and auxiliary port settings) can be adjusted through this set-up.

For more information, refer to the guide: *TCP/IP AX3000 - User's Manual*.

But, for a **fast and reliable** installation, the AX3000 provides a quick set-up function. This quick set-up function is dedicated to a typical environment:

- only one host,
- an optional router,
- all the virtual terminals have the same settings,
- a lpd or a Prt5250 printer is available.

To enter the quick set-up, select **[Configuration]→[Quick Set-up]** and press **<CR>**. A warning message is displayed, press **<CR>** to continue.

The quick set-up dialog box is displayed:

```

Quick Set-Up
AX3000
Keyboard Type      PC
Keyboard          English
Number of Sessions 4
Pre-defined Configuration 5250
NET
AX3000 IP Address  192.168.1.245
Default Router     .....
Host Name          .....
Host IP Address    .....
PRINTER
Enable
Printer Name
Manufacturer type and model
VALID             INFO             CANCEL
  
```

Note: this box is automatically called when the AX3000 is powered up for the first time.

Quick set-up parameters:

- **Keyboard:** keyboard nationality.
- **Number of sessions:** maximum number of sessions. These sessions are automatically associated with the host described above.
- **Configuration:** virtual terminal settings. This choice is selected from a list.
- **AX3000 IP address**
- **Default router:** optional router IP address.
- **Host Name:** name of the only accessible host
- **Host IP address**
- **Enable:** Configuring printers attached to AX3000. If 'Pre-defined Configuration' is set to 5250 and a hostname is defined, PRT5250 is automatically selected. If not LPD is the default printing system.
- **Printer Name** (accessible only if "Enable" is set): this is the printer name at the operating system level.
- **Manufacturer Type and Model** (accessible only with PRT5250): printer type and model.

After confirmation, all the AX3000 set-up parameters are updated.

4 - CONNECTOR PIN ASSIGNMENTS

This chapter describes the connector pin assignments for the different ports of the AX3000 Model 55E.

4.1 - ETHERNET PORT RJ45 (10BT)

Recommended wiring is a **non-shielded** twisted-pair cable (UTP), category 3 or 5

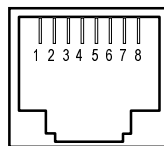

RJ45 connector (Model 55E rear panel)

Note: the maximum length of a 10Base-T cable is 100 meters (330 feet).

Pin	Signal Name	Direction
1	TX+ (Transmitted Data)	Input
2	TX- (Transmitted Data)	Input
3	RX+ (Received Data)	Output
4	---	---
5	---	---
6	RX- (Received Data)	Output
7	---	---
8	---	---

a - AX3000 Connected to a HUB

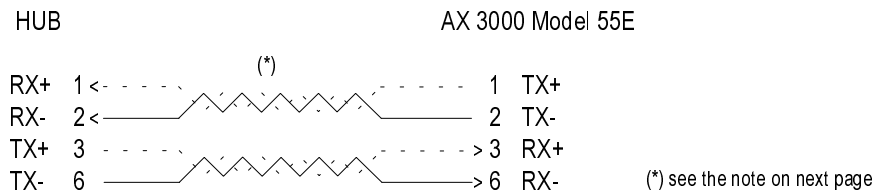

b - AX3000 Connected to an Ethernet Controller

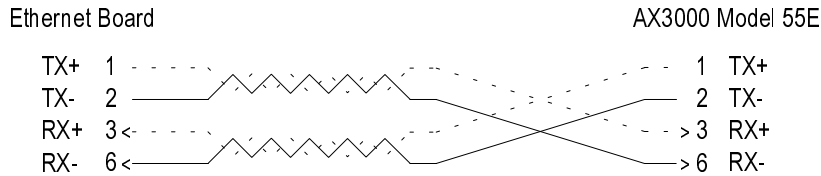

IMPORTANT: the cable is composed of two twisted pairs. The two wires TX+ / TX- must belong to one pair and the two wires RX+ / RX- must belong to the other pair.

4.2 - SERIAL PORT AUX2 (RJ45)

This serial port is a bi-directional port (for printers, bar-code readers, touch screens, etc):

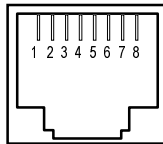

AUX2 connector
(Model 55E rear panel)

Pin	Signal Name	Direction
1	RTS (Request To Send)	Output
2	DTR (Data Terminal Ready)	Output
3	RD (Received Data)	Input
4	SG (Signal Ground)	---
5	CTS (Clear to Send)	Input
6	TD (Transmitted Data)	Output
7	---	---
8	DCD (Data Carrier Detected)	Input

4.3 - SERIAL PORT MAIN-AUX1 (25-PIN)

This serial port is a bi-directional port (for printers, bar-code readers, touch screens, etc). This 25-pin auxiliary port is in DTE mode:

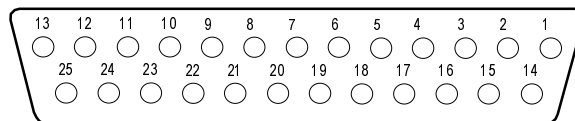

MAIN-AUX1 connector
(Model 55E, rear panel)

Pin	Signal name	Direction
1	FG (Frame Ground)	---
2	TD (Transmitted Data)	Output
3	RD (Received Data)	Input
4	RTS (Request to send)	Output
5	CTS (Clear to Send)	Input
6	---	---
7	SG (Signal Ground)	---
8	DCD (Data Carrier Detect)	Input
9	---	---
10	---	---
11	---	---
12	---	---
13	---	---
14	---	---
15	---	---
16	Reserved	---
17	Reserved	---
18	Reserved	---
19	---	---
20	DTR (Data Terminal Ready)	Output
21	---	---
22	---	---
23	---	---
24	Reserved	---
25	Reserved	---

Pin assignments for serial peripheral cables (9 or 25-pin):

AX3000 - male 25-pin		Peripheral - female 9-pin
TD	2	RD
RD	3	TD
CTS	5	DTR
SG	7	SG
DTR	20	DSR

AX3000 - male 25-pin		Peripheral - DTE male 25-pin
TD	2	RD
RD	3	TD
CTS	5	DTR
SG	7	SG
DTR	20	DSR

4.4 - KEYBOARD INTERFACE

The AX3000 keyboard interface is a Mini-DIN connector. To connect a keyboard which has a DIN connector, use a DIN-to-Mini-DIN adaptor:

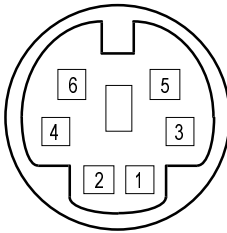

Keyboard connector (Model 55E rear panel)

Pin	Signal name
1	Data
2	---
3	Ground
4	+ 5 V DC
5	Clock
6	---

4.5 - VIDEO INTERFACE

The AX3000 video interface is VGA and SVGA compatible:

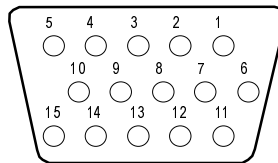

VGA/SVGA connector
(Model 55E, rear panel)

Pin	Signal name
1	Red
2	Green
3	Blue
4	---
5	Ground
6	Ground
7	Ground
8	Ground
9	Ground
10	Ground
11	---
12	---
13	Horizontal sync.
14	Vertical sync.
15	---

4.6 - PARALLEL INTERFACE

The Platine terminal Model 55E is equipped with a parallel port.

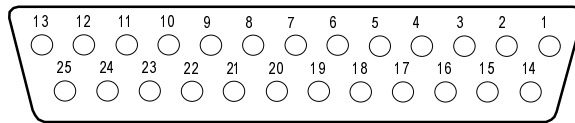

Parallel connector
(Model 55E, rear panel)

Pin	Signal Name
1	Strobe
2	Data 0
3	Data 1
4	Data 2
5	Data 3
6	Data 4
7	Data 5
8	Data 6
9	Data 7
10	ACK (Acknowledge)
11	Busy
12	PE (Paper End)
13	SLCT (Select)
14	Auto Feed XT
15	Error
16	Init
17	SLCT IN
18	Ground
19	Ground
20	Ground
21	Ground
22	Ground
23	Ground
24	Ground
25	Ground

5 - PROBLEM SOLVING

This chapter describes some of the problems, that may occur during installation of the AX3000 Model 55E, and offers possible solutions.

✓ - **GREEN FRONT INDICATOR DOESN'T LIGHT, OR NO BEEP WHEN YOU PRESS POWER SWITCH**

Check there is power at the wall outlet and power cord connections.

✓ - **CONTINUOUS TONE SOUNDS AFTER THE TERMINAL HAS BEEN SWITCHED ON**

This alarm indicates a hardware failure. Report the problem to your service representative.

✓ - **AFTER THE TERMINAL HAS BEEN SWITCHED ON, THE MESSAGES 'NO ETHERNET BOARD PRESENT' AND 'CANNOT ATTACH ETHERNET BOARD' APPEAR**

This message indicates a hardware failure. Report the problem to your service representative.

✓ - **A DOUBLE-BEEP SOUNDS**

After switching on the terminal, a double beep may sound, a few seconds after the normal first beep.

This signal indicates that keyboard initialisation has failed. Check the keyboard connection to the terminal back panel.

It is possible for the keyboard to function correctly, despite this double-beep signal. As a quick test of keyboard operation, enter set-up mode by pressing the

<Ctrl><Alt><Esc> keys simultaneously. If set-up mode is working, you can ignore the double beep signal and use the terminal normally.

✓ - **ETHERNET CONNECTION INDICATOR DOES NOT LIGHT**

This indicator is the green LED located next to the network connector on the Model 55E terminal back panel.

Failure to light when the terminal is switched on may be due to any of the following:

- the Ethernet cable is disconnected at the far end,
- the device (host or hub), to which the network cable is connected, is not switched on,
- there is a fault on the Ethernet cable or the cable is wired with incorrect pin assignments.

✓ - **NO LOGIN WHEN THE 'CONNECTING...' MESSAGE IS DISPLAYED**

Check the Ethernet cables are correctly connected and networked devices (hubs or servers) are switched on.

No connection (and no login) can also be due to a wrong terminal setting during the TCP/IP set-up (for example a wrong IP address).

✓ - **INCORRECT APPEARANCE OF SOFTWARE DISPLAYED ON THE AX3000**

Check the values of parameters set using Terminal Set-Up. Check that the correct terminal emulation has been chosen.

Check that the `TERM` environment variable (for the current UNIX shell) corresponds to the emulation selected for the terminal (in AX3000 Set-Up).

✓ - THE CONNECTED PRINTER DOES NOT WORK

Check that the cable pin assignment is correct and that the port being used (AUX1, AUX2 or PARALLEL) has been correctly selected in AX3000 Set-Up.

Test the printer in local mode by pressing the **<Prt Scr>** key. A hardcopy of the screen should be printed.

AXEL

14 Avenue du Québec
Bât. K2 EVOLIC - BP 728
91962 Courtabœuf cedex - FRANCE
Tel.: 33 1.69.28.27.27
Fax: 33 1.69.28.82.04
Email: info@axel.com